

Northern California DX Foundation Newsletter



Winter 1990

Conway and Banaba -- New DXCC Countries

(Reprinted from The ARRL Letter, December 18, 1989)

By unanimous vote (7 - 0), the ARRL Awards Committee has accepted the recommendations of the ARRL DX Advisory Committee to add Conway (3D2) and Banaba (T33) to the ARRL DXCC Countries List, by virtue of Point 2(b) of the Countries List Criteria.

Conway (3D2), a territory of the Republic of Fiji, lies about 280 statute miles southwest of Viti Levu (3D2), and over 500 miles from Rotuma (3D2). Since no activity is believed to have taken place from Conway prior to the 3D2CR operation of April, 1989, contacts with the reef are creditable effective with the start of this operation.

Banaba (T33), part of the Republic of Kiribati, is an island located approximately 260 miles southwest of Tarawa in Western Kiribati (T31). There were a few operations, with callsign prefix VR1, from Banaba, formerly known as Ocean Island, before the T33JS/T33RA activity of May 1989. Those VR1 operations will also be creditable.

QSL cards may be submitted for Conway and Banaba credits on or after March 1, 1990. Cards submitted before that date will be returned with no action. There are a few DXCC members who have been given credit for Western Kiribati (formerly known as Gilbert Islands, including Tarawa) based on an Ocean Island QSO with a VR1 station before 1979. They may resubmit this QSL card for the proper Banaba credit (along with a Gilbert Islands or Western Kiribati card for Western Kiribati credit) on or after March 1, 1990.

For more information, contact Don Search, W3AZD, at ARRL Headquarters.

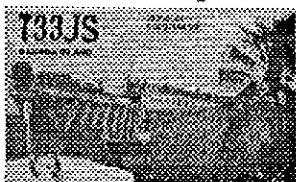

Bouvet Island

by Rusty Epps, W6OAT

I'm writing this article on the morning of January 10th. My coffee and typewriter are sitting alongside the rig. Between keystrokes, I listen to see if 3Y5X has come back to 15 meters, the only band where I still need a QSO. Without a doubt, this has been one of the major operations of the decade. Judging from the locals' comments, by now most of them have finally snagged at least one contact on some band. Congratulations to the entire Club Bouvet team for pushing this rarest of islands way down on the "Most Needed" list.

Many of you have asked about NCDXF's role in the Bouvet operation. It started at our Board of Directors meeting on June 6, 1989, when we first learned that LA1EE, LA2GV and LA6VM were contemplating a trip to Bouvet. At that time, they were trying to determine the feasibility of such an operation. What would be the means of transportation? Would a helicopter be available? From where would the funding come?

For planning purposes, NCDXF sent word to the Norwegians that we were willing to put up US \$30,000, the same amount we supplied for the Peter I trip in 1987. We were delighted with the prospect of activating one of the world's rarest DX locations, and very pleased with the prospect of working with the same people with whom we'd had such a positive relationship in connection with Peter I.

A few weeks after our June 6th meeting, we received Press Release #1 from the newly-formed Club Bouvet. Great! These guys weren't losing any time putting into action a plan to identify sources from which to raise the rest of the funds.

To everyone's amazement, a completely unexpected result of the press release was a telephone call I received from Mike Koss, W9SU. Mike explained that he was one of a dozen or so DXers

continued on page 3

Successful Membership Drive in Finland

by Jari Jussila, OH2BU/OH7RF

The field of DXing is universal. No geographical or man-made borders can keep DX signals from being heard in distant countries and continents. When it comes to the really rare DX, you can say that the weaker the signal, the better it will be heard among the Deserving.

"What is rare DX?" those still not familiar with the Eternal Enigmas and the Mysteries of the Ages might ask. One generally accepted definition is what you need is rare. But what you need depends upon your individual desires and operating patterns -- and last but not least, your geographical location. What is needed on a European scale is not necessarily sought after in a global sense.

The OH DX community wishes to salute the Northern California DX Foundation in the latter's highly valued commitment to the furtherance of global DXing. The efforts made by the NCDXF to promote international DX are duly observed here in the northern latitudes of Europe. Always eager to give a helping DX hand, we wish to assist the NCDXF in the pursuit of its activities.

Between the months of April and November, 1989, we mounted an NCDXF membership drive in Finland. We now are happy to report the results.

The NCDXF campaign was designed to coincide with the XF4L Revilla Gigedo and the 4J1FS Malyj Vystoskij Island DXpeditions by OH2BH, OH2BU and associates. The two DXpeditions provided an appropriate backdrop to the membership drive since the interest of the DX community was focused on those operations.

The membership campaign was carried out by mailing over 150 letters to DX minded hams in Finland. The letters were signed by OH3YI, Ossi Lehvas (SARL DX manager), OH2BVE, Jari Wirzenius (SARL co-DX manager) and OH2RF, Pertti Turunen (former SARL DX manager). The envelopes, copying, etc. were donated by OH2BU, with the mailing and addressing done by OH2RF and OH2BMH. The postage was donated by the XF4L and 4J1FS operators. The membership fees were collected by OH3YI.

A total of 48 OH DXers decided to join forces with the NCDXF. Their membership fees total 5040 FM which is equal to about \$1,185 US.

Northern California DX Foundation

P.O. Box 2368
Stanford, CA 94309-2368

President: Rusty Epps, W6OAT
Vice President: Stan Kaisel, K6UD
Secretary: Eric Edberg, W6DU
Treasurer: Rich Stempien, WA9WYB
Directors: Ted Algren, KA6W
Lou Beaudet, K6TMB
Bruce Butler, W6OSP
Josephine Clarke, WB6ZUC
Kip Edwards, W6SZN
Dave Leeson, W6QHS
Hillar Raamat, N6HR
John Cronin, K6LLK
Advisors: Bud Bane, W6WB
Howard Brainen, WZ6Z
Bob Fabry, N6EK
Bob Ferrero, W6RJ
Al Lotze, W6RQ
Jim Maxwell, W6CF
Kan Mizoguchi, JA1BK
Merle Parten, K6DC
Erik Sjolund, SM0AGD
Jack Troster, W6ISQ
Patty Winter, N6BIS
Beacon Project Manager:
Jack Troster, W6ISQ
Newsletter Editor & Publisher:
Steve Thomas, N6ST



NCDXF QSL Policy

Statement

NCDXF believes that part of the justification for spending Foundation funds to assist DXpeditions is to enable DXers who work the DXpeditions to obtain QSLs. Consequently, NCDXF believes that every DXpedition it assists should answer every QSL card, whether received direct or via the bureau, provided the sender is in the log and provided the QSO for which the QSL is requested is not a duplicate on the same band and mode.

Stations who send one or more self-addressed envelopes of proper size and sufficient postage deserve to have their QSLs sent to them directly. "Sufficient" means only enough stamps, IRCs or cash to cover the postage cost. All others are entitled to receive their QSLs via the bureau.

A DXpedition may request donations in excess of the postage costs, but it never should require such donations. DXpeditions may choose to answer the QSLs of stations making donations first, but they still should answer all others in a reasonably expeditious manner.

Bouvet continued from page 1

from the Indianapolis area who themselves had been working quietly for over 18 months putting together a trip to Bouvet. Working through the Saturday Evening Post Society, they already had a well planned and totally funded expedition scheduled for late January, 1990, including transportation for as many as 16 operators. They were planning a ten day, six transmitter, multi-multi operation. In addition to the amateur radio interest, they also were working with 18 universities on geological and other scientific experiments, and The National Geographic Society to prepare a magazine article and a documentary special to be shown on National Geographic's "Explorer" television series. Not only would this be a major DXpedition, it also would be a public relations bonanza for amateur radio.

Mike explained that the press release was the first inkling he had of the existence of Club Bouvet, and that it seemed an awful waste of resources to have two major operations from Bouvet within a month of each other. Shades of Heard Island a few years ago! Mike did not know the Club Bouvet opera-

tors personally, so the purpose of his call was to ask if NCDXF would contact the Norwegians and extend an invitation to them on behalf of the Post Society to join forces. All that the Club Bouvet operators would need to do would be to arrange their own transportation to and from Cape Town, the expedition's staging location. All other expenses would be paid by the Post Society. Wow, everything we could have hoped for had just been dumped into our laps!

Even with the Norwegian operators added to the Post Society's group, there still was an open berth left on the boat. Mike said he thought they were light on cw ops -- my favorite mode -- and asked if I wanted to round out the group. I gratefully accepted his invitation.

The next day, July 25, I worked LA8PF and passed the good news on to Per. As a result of this QSO, a few minutes later I got a telephone call from Trond, LA8XM, the President of the IA-DX-Group, and I quickly briefed him as well. As luck would have it, Trond was scheduled to have dinner in a few hours with the three Club Bouvet ops and NCDXF Secretary Eric, W6DU, who just happened to be visiting in Oslo that day. I next spoke with Eric and recounted all the details of the Post Society's invitation so that he could formally extend it at their dinner.

As it turned out, the Norwegian ops decided to decline the invitation. The timing of the Post Society's expedition didn't coincide with their already-scheduled vacation times from work; they believed a helicopter was essential for the DXpedition and the Post Society group did not have one; and because of strained political relations between Norway and the Republic of South Africa, they thought it would be awkward for them to depart from a South African port aboard a South African vessel. Thus, they elected to continue their own independent DXpedition effort.

The NCDXF suddenly found itself between a rock and a hard place! How could we justify spending \$30,000 with Club Bouvet when there was every indication that there would be an even bigger expedition a few weeks later which would not cost the Foundation a cent? We concluded that we could not, and regretfully withdrew our offer of support.

Throughout the remainder of 1989, both groups

continued with their expedition plans. Club Bouvet succeeded in finding the "Aurora" to take them (and a helicopter) to the island, they expanded the size of the expedition to include several more operators, and they raised an enormous amount of money from the amateur community (particularly in Japan) and various commercial sources. Although still short of their financial goal, the group departed Montevideo for Bouvet in mid-December, hoping that the missing funds could be found somewhere or would come in the form of generous donations included with QSLs.

The Post Society group, meanwhile, watched with great interest. When it became apparent that Club Bouvet would succeed in its effort, many of the operators did some serious soul searching to decide whether or not they really wanted to use up one (or more!) year's worth of their vacation time to put on a second operation from Bouvet two weeks later. Most decided they did not. For a brief time, it appeared as if the Post Society just might be able to pull off an extended trip that would stop at Bouvet and then go on to South Sandwich Island, VP8. Unfortunately, the vessel they planned to use for Bouvet already had a charter lined up for February, 1990, and was not available for the extended trip.

The NCDXF Directors held a special meeting on December 15th. In light of the changed circumstances, we determined that now it was appropriate for us to support the Club Bouvet effort and we voted \$10,000 for this purpose. It was just a few days thereafter that W9SU announced that his search had failed to turn up another suitable vessel, and that the Post Society had decided to cancel its expedition altogether.

Having two groups planning major DXpeditions to Bouvet for almost the same time did cause confusion in the amateur ranks, and, sadly, did strain a few personal relationships as well. Hopefully, though, all that is behind us now. The important thing is that Bouvet Island was on the air and that most people who needed it for a new one succeeded in working it. The thing we still need to do, though, is try to ensure that the Bouvet operators themselves do not take a personal financial beating because of this expedition. They haven't collected enough cash yet to pay all the bills. Please keep this in mind and be generous with any donation you might decide to include with your QSL.

Dear K6TMB,

Seasons Greetings

With all good wishes for happiness in the New Year 1990, for a members of NCDXF and for "Seventeen Years" of the Northern California DX Foundation.

I never forget the day I got help from NCDXF for my last DXpedition to Saint Peter & Saint Paul (ZY0SA and ZY0SB) and as I promised I'm here sending my contribution. For months I had received \$1 US or some IRCs and keep a little for the day to send my small help, OK. Now I'm sending \$20 US. It is small but it is what I can do.

In this letter I'm including my report about the hard job that I got completed - the WAZ on 160 meter CW. I'm the 10th in all the world and the first from South America according to the letter of our friend W4KA, Leo on November 12, 1989. He said "Stations that have sent in 40 QSL cards are:

1. HB9AMO - Pierre
2. ON4UN - John
3. G3RBP - Roger
4. LZ2DF - Mike
5. JA1GTF - Koh
6. DJ8WL - Peter
7. SP5INQ - Zenek
8. N4SF - Jerry
9. AB9O - David
10. PY1BVY - Ron

I would like to be the first from NCDXF also to get this award, but I don't know, and in next bulletin NCDXF you can publish, if you want to. OK? Thanks by attentions, please QSP my "big" 73 for W6OAT, Rusty and W6DU, Eric. I'm waiting news from NCDXF next time!

Sincerely yours, 161's

Ron, PY1BVY NCDXF # 1720



Letters

Mogadishu, Somalia
July 18, 1989

I have been in Somalia for six months now. Normally, I will stay here for my job, Radio Technician for the International Committee of the Red Cross Delegation in Somalia, still six months.

For ham radio, we are T5CT (N4CT), T5GG (Italian), T5GM (GW3KYN) and me. I use different call signs: T5YD, 6O1YD and 6O89YD. For my NCDXF friends, here is a sample of my QSL card.

At this time I have made 4,000 QSOs on the 14 and 21 MHz bands. I am waiting for a TS-440S from Kenwood so I can go on 28 MHz, and for the arrival of winter in Europe to go on 1.8, 3.5 and 7 MHz with an HF2V vertical antenna. For the other bands, I use a five element beam about 15 meters above the ground.

Almost every Thursday I am on 14256 kHz at 23:00 GMT. I hope to meet my NCDXF friends for a contact.

Best 73,
Yannick, T5YD

August 12, 1989

Dear Sirs:

Thank you for the newsletter and dues reminder.

The article by Kip, W6SZN, regarding QSL cards is excellent. I am in the same situation with my recent DXpedition to VP5 with QSL managing.

We made about 8500 QSOs while on the island and so far have answered about 2000 QSL cards. I have tried to answer them in the order received unless they were not found in the computer log. Just like Kip, I hold those until the ones that have labels are answered.

We are very fortunate that all of our QSOs were computer logged and a friend wrote a fantastic label program that sorts them and prints up to four QSOs on one label, which saves time and printing. We had no sponsors for our DXpedition and every dollar counts.

We had so much fun and satisfaction that our group plans to do a DXpedition each year. Next March during the ARRL SSB DX contest we plan to go to either Saba Island, Anegade Island or Grenada Island, depending on how our arrangements go.

Please inform all who are still waiting for QSL cards that I have about 1000 to go, so just hang in there.

Many Thanks,

73, DX,

Julio Ripoli, WD4JNS, VP5V

Dear NCDXF,

I felt that a note was in order to congratulate the new officers and the past officers for giving the Foundation new and improved visibility through better PR and communications. This has provided much of the impetus for improving contributions and membership. I want to congratulate Steve Thomas, N6ST, in particular for the outstanding job in the publication of the Summer 1989 Newsletter. This issue certainly exhibited his editorial expertise.

It was the last couple of newsletters that got my attention and fully informed me about the financial support that NCDXF provided to specific DXpeditions. When I put that information on our club meeting agenda and became enthusiastic about the support that was provided to "needy DXers" there was full club support for a decent donation to support your activities. In addition, several club members became NCDXF members unless you barred them for their unruly behavior in the pileups!

I am going to propose to the club that we might man the NCDXF display at the February, 1990 Miami - Tropical Hamboree if space can be allotted by the show committee of the Dade Radio Club. I will write to Patty Winter, N6BIS, to determine space required, shipping costs and other data.

We love the video and slide programs in the library, so keep them coming. We also make more than the normal contribution to the postage fund for the loan of these.

Keep up the good work!!

73,

Tom Mannix, WA4YLD
President
South Florida DX Association



W1PNR

 William D. Beal, Jr.
P.O. Box One — Dundee Road
Jackson, New Hampshire 03846 U.S.A.
CARROLL COUNTY

Confirming QSO with: Pse QSL Trk

STATION	MO	DAY	TR	GMT	FREQ	REPORT	MODE
							TWO WAY

K2JFL Form

Dear NCDXF,

With reference to the letter from the disaffected DXer from the 8th call area which you published in the Summer '89 Newsletter, I have done a manual analysis of the geographical spread of contacts during the 1989 4J1FS WPX-CW contest.

Our 63 QSOs with the 8th call area constitute 10.96% of our total USA contacts, whereas the 1989 Callbook indicates that the 8th call area includes only 8.77% of the total U.S. amateur population. Our 64 California QSOs were 11.13% of our total, yet California includes 14.09% of the U.S. hams.

Regarding call area saturation, we worked 0.156% of the hams in the 8th call area, while we worked but 0.099% of the hams in the 6th call area.

While DXing in never "fair" (it wouldn't be fun if it were!), I hope and trust that this information will help reassure all concerned regarding our operations from beautiful Malyj Vysotskij Island.

Very 73,

Chip Margelli, K7JA Operator, 4J1FS '89

Dear W6OAT:

There seems to be quite a bit of emphasis on publicity in the Summer, 1989 NCDXF Newsletter, and I have some ideas on the subject that I thought I would pass on to you.

I suggest that one of the present Trustees or Advisors be named to be responsible for publicity (that way, people could write to him or her and not bother you!).

Membership numbers could be added to the address labels, as I think they once were (if my number is 19). I think that it is more meaningful to a person to have a membership number than just to be a member of an organization. Also, not that the airwaves need another contest, but the NCDXF could sponsor something like a 24-hour NCDXF QSO Party in which members swap names, states and membership numbers, for example (why bother to swap 59 or 599 reports?).

I am enclosing one of my new QSL cards. As you can see, I am using the NCDXF logo on the left to balance my name and address on the right in a common W4MPY QSL design. I suggest that a write-up be put in an NCDXF Newsletter asking members to send to the NCDXF (or to the person in charge of publicity) samples of their QSL cards with the NCDXF logo on them. The logo either could be printed on or else put on by a rubber stamp or sticker. It wouldn't be a QSL design contest, but publishing a representative selection (showing different locations, sizes and methods of applying the logo) in another Newsletter might give some members ideas for their next QSL design, which could publicize the NCDXF.

73, Tony Berg, W1OT Stow, MA

Note From The Editor.

Thanks for your suggestions Tony. As space is available, I will print representative samples of interesting cards we have received, especially those displaying the NCDXF logo. Unfortunately yours got lost in the shuffle or it would be included in this issue.

73, Steve Thomas, N6ST

Dear W6OAT:

Your article "Looking Ahead" in the NCDXF Winter '89 Newsletter has prompted me to pass along a few thoughts. To begin with, I have no quarrel with the purpose and intent of the organization. I have been a DXer for many years, although I am not quite so gung-ho about it as many of you, and that is fine too. I had the opportunity to be a DX station of sorts (KB6JKO and AH2AB) on Guam. Although this is not "rare," it is needed by a lot of hams and I had the enjoyment of giving out this place for a couple of years. There were a lot of hams on the island, but many of them didn't QSL even though they promised they would.

But I am not writing to you to tell of my experiences. My purpose is to comment on your need for greater visibility. Although I have heard of your organization for many years, it is only recently that I found out more about your purposes. I, and I feel many others, felt that this was some sort of exclusive club for gung-ho DXers and all others need not apply. Also, by the very nature of your name, it has the connotation of a regional bias or a territorial exclusion of others. I strongly suspect that if you intend to get more hams interested in supporting your goals, you are going to have to do something about your name. Many hams in the mid-west (I was also KB0HI), and certainly thousands in the east (I was also formerly KN1JJA) have a great disdain for California hams, notwithstanding that the "Northern" part of your name tends to disassociate yourself from the rest of California. If you find that hard to believe, just ask the average ham about the "California Big Guns" crowding the bands, especially in contests.

It is indeed unfortunate, but the cost of being a big state with numerous hams is that you are going to have your proportionate share of lids with a higher degree of visibility. I could relate a few of my own experiences while on Guam with some of the jerks who call themselves hams and who happen to live in California, but you and I know that those experiences could also relate to hams in other states. I guess that California is the state that many people love to hate, and therefore non-California hams will remember California lids with greater ease. If Nevada and Arizona were suddenly to be

annexed by California, we too would be included in that hate. Am I making myself clear?

Another factor in your disfavor is that nearly everyone on your Board of Trustees is a California ham. I find it surprising that there is only one among you who got his call elsewhere and will not give it up.

I do not share the views of many non-California hams, and I will start to support your goals with my small contribution in the immediate future. May I also express my personal thanks for the use of your slide presentations that I have used to show to our local ham club. They were enjoyed by many.

I am sure that you are too busy to reply to everyone, so I will not expect any reply. May I wish you and the NCDXF continued success in all your endeavors.

Warm wishes and 73,

Alan Davis, KB7HM
Las Vegas, NV

Dear Friends,

I was very glad to get the Certificate of my NCDXF membership. Thank You!

As you asked, some about myself. I'm 29 years old, married, 2 children. My profession is a Technician for aircraft radio equipment of Civil Aviation.

As a ham I was licensed in 1984. This time my 1st Category License allows me to operate with 200 watts power on all amateur bands by CW, SSB and AM. All my rig I made myself and/or with the help of some of my friends. Most of the time I like to operate CW.

There is no definite direction in my operating on Amateur Bands now. Amateur Radio attracts me as the possibility of communications with Wild World and also as a work by construction of new electronic systems. However, I try to take part in Contests, operating for Awards and DX.

All my spare time I'm dividing for operating on air and for construction or repair of my Rig.

Here is something about Ham Radio in my area. Tourkmenia (or "Turkoman" by DXCC list) is not little amongst Republics of USSR by it's area, but it takes one of the last places by number of inhabitants. As Radio Amateur Country, Tourkmenia is divided into five regions (oblasts) by "R-100-O" Award list:

Oblast 191 is Ashkhabad as capital city of Tourkmenia. Here are about 60 licensed hams as individual stations and 3 club stations. Belonging to Oblast 191 by callsigns with the letter "A" after prefixes: UH or RH.A.. But there are some stations in Ashkhabad with callsigns UH8BO, UH8BZ, UH8DI - they are our Veterans in ham radio.

Club (collective) stations: UH9AWA - Republic's Central Collective Station, UH9AWE - Tourkmen University's Club Station and UH9AWC - station in the Technics College. All 1st Category Licensed stations have two letter suffixes, all club stations are 1st Category.

Oblast 193 is region around Ashkhabad and Krasnovodsk - the city on Kaspj lake coast. Callsigns: UH/RH.H.. or UH/RH.B.. Number of hams is about 30.

Oblast 044 Mary city and region. UH/RH.E.. There are no more than 15 hams now.

Oblast 045 Dashkhous town and region, UH/RH.W.. There are only 2 hams and club station UH9WWA.

Oblast 046 (my native land) Chardzhow UH/RH.Y.. There are also few hams. I know only five of them.

Insufficient activity of Ham Radio in Tourkmenia make it "DX-country" for World Amateurs, and even for USSR's hams. The passivity may be explained with many reasons. For instance difficulty of home construction of the rig, non-interest of the administration and so on. However, I can say that there are some non-official groups and movements amongst amateurs, which makes all possible for development of Amateur Radio in Tourkmenia. One of them try now to make as few errors as allows him his English in this letter (hi!)

And some questions for you:

1. How can I be useful to The Beacon Program, and what the reports form of my listening Beacons? What periodicals are interesting for you?
2. Can I be useful as NCDXF member in your other works?
3. Please send me the NCDXF log or Request form for that.

I hope to be very useful for NCDXF and I'll always try to make all possible for Amateur Radio development.

Thank You again. 73 es DX

Andrew, RH8AX (NCDXF #3984)

A.R. Yagmurov

Ashkhabad, GAUDAN - "W" 6/32

744030, Tourkmenia, USSR

USSR

RH8AA Vkhaly A. Kozin

RH8AX Andrew R. Yagmurov

WAZ ZONE 17 URSR 191 ITU ZONE 30

QSO WITH	CONFIRMING QSO					
	BY	MONTH	YEAR	BY	MONTH	YEAR
NCDXF						

QSL FOR RPTCC 73
PSE QSL TRX. Turkoman, Ashkhabad

Norfolk Island

13th October, 1989

To: NCDXF

Re: DXpedition to Bouvet Island 1989/90

Greetings from our small island in the South Pacific to you all at NCDXF, our fellow DXers. Due to the on-going Australian airline problems and the resultant unreliable mail service, I felt it better to FAX this letter rather than to mail it. Please excuse any degradation of quality. I hope that this correspondence will be available in time for the meeting of The Board of Directors of that reputable U.S. DX Foundation affectionately known as North Cal.

Here on Norfolk Island we recently received a copy of the Club Bouvet release number 3 (delayed by the mail problems) which outlines the progress of the Club to date. With an awesome target figure of some \$100,000 (one third of total expedition costs) the group have done a very credible job. Assisted of course by the DXers of the world, a total of some \$65,000 has already been raised, with a further \$10,000 pledged. There is then a balance of some \$25,000 remaining but this release is some weeks old and further funds may have been received. The obvious enthusiasm that Club Bouvet has generated in DXing circles speaks for itself. It is proved by that super-human effort of achieving the figure stated. I would be prepared to bet (although I am not a betting man) that NCDXF for example might have problems in raising that sort of money.

The reason for this letter is to express my extreme disappointment over the failure of the NCDXF to provide any funding. Not a single dollar pledged, not a single token donation of say \$1,000 so routinely given to many of the "hands out" operators who continually request NCDXF funding. With Bouvet Island on top of the needed list of available non political, non "no amateur radio" countries of the current DXCC list -- I can only express my amazement and ask why?

The LA Group gave many a new one in the shape of Peter I, the NCDXF received some \$10,000 of its funding back -- surely a sterling effort on behalf of DXers who supported this operation before and after the event. Not to mention the LA operators themselves. I believe that Peter I proved what can be done in the way of International Funding when

the need arises. If anything, current events with Club Bouvet Island prove the point yet again.

I was moved to telephone [NCDXF Director] Bruce Butler, W6OSP, because in release number 2 the Club Bouvet has stated "no major funding from the U.S. Clubs or Associations" (very similar to my statements over Heard Island in 1982/1983). Bruce confirmed that the Foundation had not allocated any funds to this operation. This letter then expresses my concern over the situation.

The NCDXF must be aware of the "Big Business" picture it seems to generate these days amongst many DXers. Over and over again, one can read how the Foundation "took a chance," gave the necessary "seed money" (a North Cal expression). All apparently adding to the picture mentioned. The "racing certainty" is the dream of all of us.

Bruce stated, that with "the other DXpedition" to Bouvet Island already fully funded, it was felt that there was no need for the Foundation to assist the LA Club Bouvet operation.

In its most simplistic terms, I believe that the Foundation owes the LA Group support -- based on the past sterling efforts on Peter I. The Foundation who were in there early, should have stayed, leading the way in DXing circles. Instead, it has dragged its feet, prompting the very pointed statement by the Club Bouvet in release number 3. In short, it appears to be obvious to whom they are referring.

Since the "other group" (shades of Heard Island again) has not requested any funding from NCDXF funds, surely this is all the more reason for the NCDXF to act positively -- without reservation. It is what the DXers who donated to the Foundation's Funds (as distinct from the Trust Fund interest) would wish, at least that is my opinion. When will the DXers get another double chance at Bouvet?

In discussion with Bruce, he also pointed out that the "other group" had offered "Free Places" to the LA operators. This is of course a generous offer on behalf of the U.S. group. It is also agreed that LA Group has turned this offer down. However, their reasons are clearly and quite adequately stated in release number 3.

In a recent article "Looking Ahead" by Rusty, W6OAT, [Page 6, Winter, 1989, NCDXF Newsletter] he stated, among other things: "Where the

Foundation can help is in assisting DXpeditions to the geographically remote DXCC locations. In this regard the Board of Trustees has resolved to make bigger grants, to take greater risks, if that is what it takes to get these countries on the air. There are other comments on how DXers view NCDXF and how this image is to be improved on etc." Finally the paragraph ends with statements which are not accurate regarding Peter I.

Regarding the proposal (also to hand here) written by the "other group," one must comment on it being very professional and excellent in its layout and presentation. It must have been successful since they have no problems with funding, the dream of all major DXpeditions. As the Board knows, I wrote precisely the same sort of documentation for Heard Island, Kermadec Island 1984, and more recently for The Kingdom of Bhutan. There is a great deal of ongoing documentation being prepared for DXpeditions. However, it is flawed in one respect -- far too much is taken for granted. Too much of an assumption that all will go according to plan. There is nothing wrong with enthusiasm and belief but if there are weather problems, there will be difficulties. Their location is dictated the method of getting ashore, namely by boat. This area may or may not be in a reasonable state due to years of cliff fall and erosion. Further, large areas will be cut off (in a propagation sense) by the cliff edges of Bouvet Island itself. Finally, the available time slot is short, with that curse of many major DXpeditions -- no leeway, a major factor. Time and time again, it has been proved that things will and do go wrong. Of course, Club Bouvet may also have problems but that helicopter is going to make a great deal of difference. A better site and the much longer time frame, is in my view, an added bonus.

Nothing is guaranteed in this world and we who are interested in DXpeditions always have to take a chance. I would have thought that two DXpeditions are better than one, there is no conflict of interest, e.g. sharing funding. There is no splitting of resources with the "other group" which is fully funded from commercial sources outside amateur radio.

Finally, I honestly believe that a "No Funds for Club Bouvet" by the NCDXF will be counter productive. Such action will merely strengthen existing views shared by many DXers.

Since Heard Island days, and my then very public statement, "of a desire to move some of the emphasis (for DXpedition Funding) away from the U.S.," events have exceeded my wildest dreams. HIDXA goes from strength to strength, the DXer has seen the creation of the EU DX Foundation, The French DX Foundation and so on. All are naturally competing for funds in the DX market place, funds which might have gone to the NCDXF. If the LA group can raise \$75,000, what then is the potential for "North Cal." The tremendous input of over \$40,000 (again I quote from release number 3) by the DXers of Japan would have been almost unheard of, say, ten years ago. NCDXF may well get left behind in the rush, hi.

I agree with Rusty, the NCDXF has indeed achieved a great deal in years past, but my own view is that a bit of the old "North Cal" magic has gone. This may be quite an unfair observation and the apparent changes merely reflecting the tremendous movement in the hobby and DXing in particular. Things did appear to be easier a few years ago. However we do know just how fickle the DX public are -- they want to know what is going to be done today and tomorrow. They already know what was achieved yesterday (when will you be on 80M?? etc).

Please reconsider your current decision of "No Funds" for Club Bouvet and weigh in there with a donation with no strings attached. All of us who have donated that \$65,000 and pledged that further \$10,000 are in exactly the same boat. However to be sure there are a couple of things, receipts are being given for all Bouvet DXpedition donations. They say, "money back if we don't go". It is very difficult to see what NCDXF has got to lose and how somehow their risk will be any greater than the rest of us who believe in DXing.

Gentlemen, I have taken too much of your time. Please accept this input to your meeting in the spirit it is intended. A genuine desire to see Club Bouvet make it to Bouvet Island for the benefit of all of us who call ourselves DXers. Perhaps more to the point to see NCDXF flourish in its furtherance of DXing.

Yours in DXing, 73,

J. B. Smith, VK9NS

HIDXA

Am I In The Log?

NCDXF Members On Insurance QSOs

by Kip Edwards, W6SZN

A couple of issues ago, I solicited your views on the subject of insurance QSOs -- how to avoid getting your QSL back marked "Not in Log" and, at the same time, how to avoid being a duplicate QSO on the same band and mode ("You're In Good Hands With ...," Winter 1989 NCDXF Newsletter). The responses demonstrate diverse views on the issue and suggest

that the problem is unlikely to go away.

Several responses blamed the DX operator as being the cause of errors, resulting in cards being returned "Not in Log." The complete answer to this charge: Of course! I don't know how others handle busted calls, but we sent a 3D2XX card anytime we could conclude, with reasonable certainty, that we had screwed up, e.g., WA9WYB sends a card and the cw log has WA9WYD, or K6MAR sends a card and the log shows K6QR.

Rather than characterizing the responses, I decided to publish excerpts and let each of you form your own conclusions. My sincere thanks to all who responded.

-- de W3YX: "I only work a DX station once in contests or for new countries. I always think I may be depriving a kid of a new country if I try for more than one contact. This could result in disaster as in the case of 3Y, Peter I Island. My card came back 'Not in Log.' That hurt!"

-- de K5ZD/3: "I am opposed to making insurance QSOs with a DXpedition just to have two entries in the log. Maybe it's my contest background which inhibits "dupes." Unfortunately, the general level of operating skill demonstrated during DXpeditions has made it difficult to reliably tell who is working whom. The worst dilemma is trying to decide whether the station you worked is the real thing (not a slim!). The DXpedition guys don't always repeat the call they get either! Put me down for allowing two QSOs with a DXpedition before declaring someone a lid."

-- de KK4LM: "Never had a "Not in Log" and do not believe in insurance contacts."

-- de K1VHS: "For me it boils down to one thing: as

long as there are humans involved with their varying amounts of skill and expertise, people will need to buy insurance. I believe I just worked 3W0A twice on 20 cw because I did not hear him send VHS on cw the way I like to hear it, i.e., with just the right amount of dots. I applaud the process of trying another band, but sometimes it's tough with varying propagation and personal schedules. Another mode isn't always appropriate because many of us are chasing both SSB and CW DXCC. Yes, I'm guilty of an insurance contact once in awhile. ... I support using them if there is any doubt but the first order of business is to get the operator at the other end to say or send your call completely the first time. To conclude: Use them, but use them judiciously."

-- de K6FD: "Can you safely rely on the DX operator to get it right? We have to! He makes the log entries. Competent DX operators do an excellent job of log keeping. Are there things that the DX station can do to increase the chances that your callsign gets into the DX log correctly? The DX station must maintain "circuit discipline" on his frequency. This is the most difficult part of the "logging process" because worked operators are excited and many of them don't think clearly about what they are doing. The best thing for the DX operator to do is ask for cooperation from the offending stations and if he doesn't get it, announce to the assembled hoard "KX6XXX is not in the log and will never be in our log because of improper operating practices." And keep that promise!"

-- de NT0W: "I firmly believe in duplicate or insurance contacts. Sure, they cause more time and effort for the DX station, but what about the US amateur who spends hours on the radio trying to catch the DX station on when they don't stick to the published schedules, or when it takes long periods of time to break through the pileup to work the guy, only to have him say "QSL the 59, QRZ" without really repeating your callsign clearly enough so you can be certain he had you in the log? I know many DX stations don't like duplicate contacts, but many times I find that they are in such a hurry to log as many stations as possible that they write the call down wrong. A good DX operator will stay with the station until he gets the call correctly."

-- de DK1RV: "Since I get a "Not in Log" from

[DXpedition], I try to make an insurance QSO for a new one as well as for new mode or/and band."

-- de WD4AIE: "After sitting for hours, literally, repeating my call over and over and listening ... finally "India Echo you're 59" -- and I reply with my full call and listen! What to my wondering ear should be heard: "He's operating up 20" -- "Shut up and listen stupid!" -- followed by a tuner-upper! Hooray! Now, did the DX station get my call, which is WD4AIE, or did he mean another India Echo? What do I do now? Throw the several hours out the window and hope? Not bother the DX station with an insurance contact? You tell me. It is the DX station's party! He's the one to be satisfied, and how he wants to work the airwaves is strictly up to him. The policemen, QRMers, lids, hard of hearing, slightly drunk, drunk, tacky, profane and rude merely add to the carnival. As a result, with the Yemen station, I got mad, disgusted and finally decided the whole mess was a hilarious fiasco and turned the receiver to another frequency and had a delightful QSO with a GM in Scotland. Guess what? He didn't even know there was a chap on from Yemen!"

-- de K8LWP: "I don't believe in insurance contacts myself, but if the DX op or logger is not sure, they could ask for a repeat, like "LWG? K." I myself have a lot of confidence in the DXpedition operators in the remote areas or islands of the world. You say 12.4% dupes? Well, a lot of fellers missed a new one."

-- de NZ7Q: "If I have some doubt my call was correctly logged, I will go for the insurance. If my call was distinctly given, I will not log him again. Simple as that. I have had two cards returned as "NIL." Both I would have sworn gave my call and report. Still, all in all, the record is good. I have heard some operations that go for long periods without giving an ID. Surely, that causes many dupes."

-- de W7YF: "For the past one and a half years I've been the QSL manager for YB3ASQ (Bob Preston, W7TSQ) in Surabaya, Java. I've noticed a surprising number of incoming QSLs -- mostly from the USA -- which may have the correct GMT time but the incorrect date. This suggests that many US hams don't seem to realize that when the clock in GMT moves from 23:59 to 00:00, the date also moves ahead in GMT. I bounced several such QSLs as "Not in Log" at first, before I realized what was

happening here -- then I simply checked the logs against the right time but wrong date, and yep, many fell into this category. So if some folks received a YB3ASQ in return for theirs with what seems to be the wrong date, they might recheck this item.

-- de WX6M: "I have been DXing since 1980. During that time, I have had only four come back "Not in Log." In the beginning, I would only work the guy once regardless of band and mode. However, after getting the first one back "Not in Log," I started getting a second contact on another band for an insurance contact. I think that this is all the insurance one should need. Some people will say, "What about 5B-DXCC?" I, too, have been casually working for 5B-DXCC over the past three years or so. Since it is not hard, at all, to get 100 countries on each of the high bands, I see no need for insurance contacts on those bands. However, due to QRM, QRN and weak signals on the low bands, one might feel it is necessary to get insurance contacts on those bands. This would depend on if you had a good solid contact or not, and how important it is to that particular person to make 5B-DXCC in the next thirty days or less."

-- de WA9AQE: "I don't believe in insurance contacts and I've never had a QSL returned with "Not in log." I believe the main skill in DXing is to listen, listen, listen! I am careful to note that the DX station sends my callsign back correctly during the QSO, thus I am very sure he/she got it right. It also helps to be very careful to get the correct date and time (UTC) on the QSL. The only other error at that point would be omission or transposition of my callsign letters. I believe too many DXers, especially causal types, do not listen closely enough and do not time their calls properly."

-- de WA6AUE: "I have received very few "Not in Log" rejections. I think that the modestly experienced operator knows, or feels, when his call did not come back to him quite right. That might require another contact. But most of the time, the good DX operator sends your call (or the part he missed the first time) back to you and you hear it and know it was a good contact. One cause of multiple contact is the expedition operator who does not resend the corrected callsign back to the station he is working. This leaves the deserving station unsure as to whether his correction was copied accurately or not. He will probably stay in

the pileup. Some DX operators send too fast for the band conditions. If they are weak/unreadable, it causes doubt at the other end which may result in dupes or insurance contacts. Receiving a card marked "Not in Log" is not an enjoyable experience, especially from a seldom activated country. The accuracy required for a good contact is the responsibility of the DX station and the station working it -- or let's see now -- maybe we could have a guy in the middle of the two stations and he could be sort of an MC, to aid communications, and he could say things like "Good contact!" or "Over, over" [Knowing Jim, I'm sure the last suggestion is in jest! .. de W6SZN]

-- de WG6P: "I will admit that most of the time I do make the safety contacts, as I have gotten back several "Not in Log" contacts that I thought were solid. Anyway, there always seems to be very heavy QRM whenever an expedition is out there. First of all, let me say that I never make safety contacts where the country in question has operators living there. It's only for the rare ones, or uninhabited ones. Examples would be Clipperton, Mellish, Laccadives, etc. I think when an expedition is out there, they should confirm calls a little better. Sometimes, on ssb or cw, with split operation, you hear, for example "6P?" After responding, the reply is "Thanks, QRZ" or "TU." Now, you don't know for sure if it was you or not! So the temptation is very great to wait and make another contact or two until you are sure that it is solid. ... In closing, let me just say that I think safety contacts are a sign of the times. The bands are too crowded, many people are upgrading and jumping in piles, creating QRM, and not knowing how to operate. The only suggestion I have is to confirm on the air so there is no question. I can say honestly that I have only gotten about 40% of the time rock solid Qs with an expedition on the first contact.

-- de WA1WTP: "I have had a couple of "Not in Log," but thank goodness, not from irreplaceable countries. My points of protocol -- 1) Only one contact per mode per band; 2) I should repeat my call before replying to DX report; 3) The DX station should acknowledge, i.e., "WA1WTP TU;" 4) If he gets my call wrong, I have the privilege of trying for a second contact. I realize my method causes much more time per contact for the DX station, but it sure lets a lot of amateurs sleep better at night."

-- de W9QBJ: "A thought: if operators signed their calls at the end of their report exchange, possible errors might be eliminated."

-- de RF6QAI: "Computer analysis of my log for 1987 cw/ssb disclosed a duplicate contact rate of 7.3%."

-- de NR5Q: "I bought a small, front loading, cassette recorder and connected it to the audio of my transceiver. Now when I start working DX, I record everything. If I work a rare one, I dupe it off onto a cheap 30 minute tape. When I send the QSL, I enclose a note to the DX station or manager saying that I have the exchange on tape along with "X" number of minutes of the DX operation and that I will be glad to send him a copy of the tape if he would like it. Several do request the tape ... not so much for confirmation, I think, as that they just want to hear what they sound like. It does cost a few dollars a year, but we now seem to get our QSLs along with many nice letters thanking us for the tape."

-- de WA8LLY: "The situation has really gotten out of hand in the last few years, and something must be done to correct the problem. I have made what might have been insurance contacts on several occasions. These situations have occurred when my call has been copied incorrectly, usually as WA8RLY/6 or WA8LRY/6. Under these circumstance, I send my call twice, the signal report and my call again. About 75% of the time, the DX station responds with "R." Roger what? I have no choice but to make another contact because I don't know if they have my call correctly in the log. ... I believe the 30+ wpm code speed used by most expeditions makes the problem worse. The standard procedure seems to be to transmit at 25 kHz from the band edge, listening up 3 - 5 kHz. This seems fair, as all US license classes can transmit in this region. The flaw is that the vast majority can't copy the 30 wpm transmissions. Many of them probably can't copy their calls at that speed -- they needed only 13 wpm to get the General or Advanced class licenses. So, when in doubt, make an insurance contact...or two...or three...or eleven! I personally believe that the first day of cw should be in the Extra Class subbands only. I think the rate would be higher due to less QRM and the dupe rate lower due to better operators. On later days, go to a lower cw speed and listen in the General and Advanced class subbands. Insurance contacts will

remain a problem until there is a penalty for making them."

-- de OH2VZ: "The question about the cards returned "Not in Log:" It happens sometimes. I believe it happens most often on 7 and 3.5 MHz, where the difference between the split frequencies is smaller than on the higher bands and the QRM is heavier. We also have deliberate interference which often disturbs the receiving frequency just at the crucial moment. I believe that many duplicate contacts can be avoided if the DX station repeats the callsign of the callsign he is working. I also believe it is important that a DX station listen from time to time on his own frequency, because often there is deliberate and accidental interference on the transmit frequency."

-- de K8CSG: "I try to make a duplicate on another band or mode -- an "approved" procedure as you noted. If that is not feasible, I try to make a second QSO on at least another day. If I do not make the second QSO, which is not all that unusual, I often wonder if I will encounter another situation where my only QSO came back Not in Log. Fortunately, this has happened only once. Where do I stand? On really rare countries which DXers need for brand new counters, I have absolutely no objection to a nice, crisp insurance contact after a decent interval -- hours or days. Beyond that, it becomes abusive. Good operating practice always works to assure accurate logging at both ends. Sometimes persistence may be needed in the face of QRM, deliberate or otherwise, poor propagation, etc. It pays to be certain."

-- de WA1ZLD: "Generally, I work a station a second time because of poor propagation or QRM on the DX station's frequency (lids and/or policemen). I am totally in disagreement that anyone should work a DX station more than twice. Too many rare DX stations do not send their callsigns at least every four or five minutes. They should do so, and when they do, they should send their callsign twice. Invariably, if they only send it once, a policeman or a lid will wipe out part or all of it."

VP5V DXpedition

For the 1989 ARRL DX Contest, Julio, WD4JNS, Bruce, W4OVU and Scott, WS4E traveled to Providenciales, the western most island in the Turks & Caicos. They made a score of 5,153,031 points and overall made 8500 QSO during the expedition.

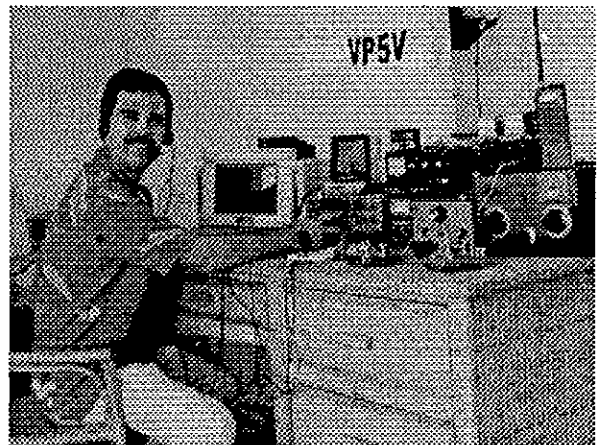

Julio, WD4JNS at the mike at VP5V. He was the DXpedition organizer and QSL manager. As you can tell from his personal QSL card, Julio is an Architect.

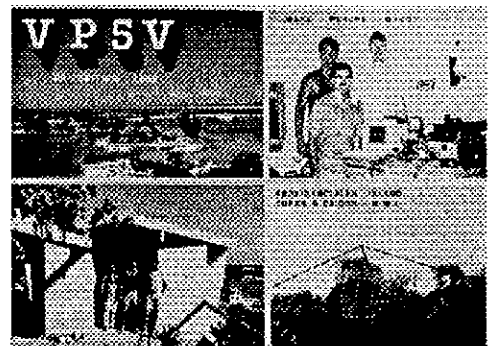
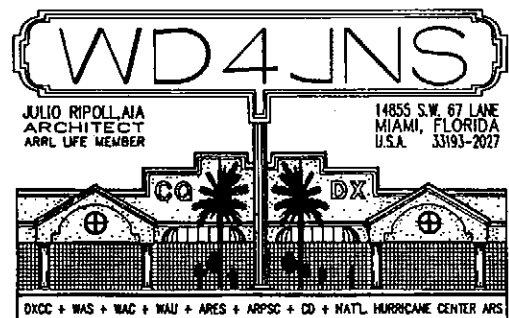

DX Packet Spotting Network

by John Cronin, K6LLK

Dayton 1989 brought attention to the newest thing in DXing? "PacketCluster", Dick Newell, AK1A the founder of Pavillion software and the father of PacketCluster was given a special award at the SWODXA banquet commemorating the DX PacketCluster movement that is sweeping the country. The PacketCluster software is the basis for the DX Packet Spotting Network you may have heard about? It's the latest rage for DXer's old and new. You say ok but what is it? PacketCluster is an innovative software package run on a MS-DOS or compatible computer which provides DX and contest announcements. PacketCluster uses it's multi-connect capability to allow many individual stations to connect to each (NODE) or computer at the same time. The DX Packet Spotting Network is used by DXer's to announce the presence of DX stations in various amateur bands. When a DX announcement is made it is sent to each connected station and is stored on the (NODE) computer hard disk for later reference. In addition, the node software provides communication between users, general and local announcements, calculation of great circle distances and beam headings, propagation calculations and many other features of interest to the Dxe and contest operator. Ok Im' following this so far?, but what is the DX Packet Spotting Network itself? Packet Radio is one of the newest modes of amateur radio communications. In many ways, Packet Radio has been a solution looking for a problem. A network consists of many different computers or (NODES) all tied together through a linking system called a "Backbone".

EXAMPLE PACKET NETWORK:

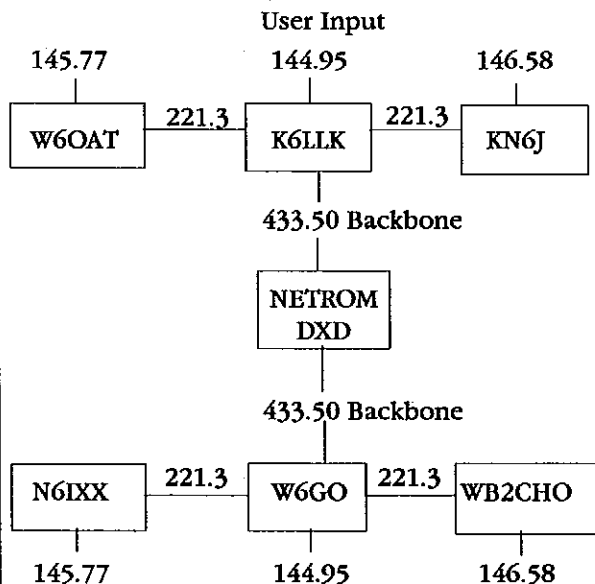

The Network pictured above, assuming 32 users per (NODE) would support a total of 192 users. In this scenario the stations are geographically separated, thereby allowing the re-use of the same frequencies in different area's. Each PacketCluster (NODE) has its own computer, multiple transceivers and antennas. Is all this of any value to the DXer or Contester? Recently the DX Packet Spotting Network in Northern California was put to the test in the CQWW SSB contest. The DX Spotting Network earned a score of 1,465,000. That means if you had worked all the stations reported during the contest over the network your score would have looked like this:

BAND	QSO'S	ZONES	CTRYS	DUPS
----	----	----	----	-----
160	5	4	5	7
80	41	16	30	37
40	83	27	52	79
20	246	35	109	273
15	182	32	101	171
10	351	35	140	477
----	----	----	----	-----
ALL	908	149	437	1044

Your Score: 1,465,000

Do you need PacketCluster? Well of course that's up to you!

PacketCluster may just be the most exciting thing to come along to DXing since SSB. It brings together the world of DXing and computers and provides countless hours of excitement and enjoyment for hams of all ages.

N4BIG

CHARLOTTE, NORTH CAROLINA, U.S.A.

Ervin Jackson, Jr. 1835 Pinewood Circle, Charlotte, NC 28211, 704-366-9230

QSO WITH	CONFIRMING QSO						
	DAY	MONTH	YEAR	CAT	BAND	RST	MODE

This visual pun is certainly worth reproduction - if only he had a BIG NCDXF Logo on it also!

Brazilian Beacon Stations

A beacon system has been established in Brazil to help check propagation into South America. The Brazilian beacons are at three locations. PY2AMI at Americana, Sao Paulo operates on 1.825, 3.525, 7.048, 14.105, 18.100, 21.105, 24.930, 28.300, 50.075, 144.05, 222.05 and 432.075 MHz. PT8AA in Rio Branco, Acre operates on 28.306 MHz while PT7AAC in Fortaleza, Ceara, operates on 28.303 MHz. All the beacons run 5 watts into a ground plane for all frequencies above 24 MHz (plus 18 MHz) and into inverted vees on all other frequencies.

PY2VRX is the project coordinator and PY2NTD is the technical resource. Also collaborating on the project are PY2AXX, PY2FUZ, PY2SW, PY2PI, PY2ZE, PU2TMC, PU2TMO, PU2WBS and KD6EU. Please send reception reports via the bureau or to the Callbook addresses for PY2AMI or PT7AAC. Reports for PT8AA go to Box 149, 69900 Rio Branco, Acre, Brazil.



This is Mike Weiler, GSWL-69, along with his XYL Susanne and son Mike Jr. Mike is a very dedicated SWL. He publishes the Monthly DX-NEWS Newsletter. This informative publication is available for subscription via Stormstrasse 126, 4130 Moers 3, West Germany. Mike regularly publishes NCDXF information.

New Slide Shows

by Josephine Clarke, WB6ZUC

The new slide shows include one by W7SW covering several trips he made to Antarctica and the Orient - quite a coverage of locale. The Banaba slides by Bob, KN6J, are of his DXpedition with Jim Smith, VK9NS, to this country which they activated to give us all a new one (see story on page one) The hardships and delays they ran into make you appreciate their efforts even more when you see these slides. The new XF4L slide show is about a group which went to Reviolla Ggedo in 1989 and did a fine job of operating and of training a local operator to keep this one on the air after they left.

As for the videos, Navassa is a new show by a group which went to that island in 1988 and made a good many DXers happy with contacts. N2OO supplied us with the video of his operation in 1989 from Rhodes with interesting coverage of SV0AA's station and of the scenery in Athens and Rhodes as well as the operation. NOIS give us the Howland Island 1988 DXpedition to this rare spot in video to make us feel as if we were there with them. As with many of these trips, it wasn't easy.

Finally, our first China video showing the Chinese Electronics week exhibition of 1988 and a shot of the Boeing group at the Great Wall communicating directly with the USA and Canada. The sequence about a Fox Hunt across a group of islands and about the Army unit providing free repair for electrical equipment is most interesting.

These programs provide some new DXpedition pictures to parts of the world which we haven't been able to see before and help us appreciate some of the efforts which are made to put a new one on for us.



Facts About The Northern California DX Foundation

The Northern California DX Foundation was founded in 1972 to assist worthwhile amateur radio and scientific projects with funding and equipment. Although the words "Northern California" still appear in its title, the activities of the Foundation are international in scope rather than regional.

The Board of Directors is responsible for overseeing all of the Foundation's business and DX support activities. Most of the Directors and the volunteer Advisors who assist them have held responsible positions in the business or academic worlds. They all are active amateurs and ardent DXers with the Honor Roll well represented. The Foundation does not have a paid staff, and no Foundation officer, Director or advisor receives a salary or compensation in any form.

Foundation Funding

At its inception, the NCDXF received a substantial capital donation from Lee Shaklee, W6BH. The Foundation has carefully invested this capital. The interest income it earns, plus contributions from members, provide the funds the Foundation has available to spend each year on DX and scientific activities. We cannot overemphasize the importance of our members' initial and follow-up donations because the interest income alone is not sufficient to cover the Foundation's annual budget. The Foundation is an organization described in Section 501(c)(3) of the Internal Revenue Code and all contributions are tax-deductible to the extent permitted by law for United States taxpayers.

Application Processing

The Foundation makes cash and equipment grants to projects it believes will benefit amateur radio in general and DXing in particular. The Directors review each application for assistance, so anyone requesting support usually should allow at least two months lead time for action. Upon receipt of an SASE, the NCDXF Secretary will send instructions to any potential applicant explaining what information the Foundation requires and how to complete the necessary application forms. Send all

requests for information and financial assistance to the NCDXF, Post Office Box 2368, Stanford, CA 94309, USA.

Equipment Donations

The Foundation encourages its members to donate equipment which is in good working condition. Members who are U.S. taxpayers may deduct the fair market value of such donations.

Membership

Everyone is invited to join the NCDXF. We suggest an annual contribution of US\$25.00 or its equivalent in IRCs. New members will receive a handsome 8.5 x 11 inch full color membership certificate, and the NCDXF's highly informative Newsletter is sent twice each year to all current contributors. However, the Foundation does not want to deny membership to anyone because of financial hardship. Anyone wishing to be a member who cannot send the full suggested amount should send whatever other amount he or she can.

Slide and Video Programs

The Foundation has assembled an extensive collection of slide and VHS-format video programs of DX oriented material which it loans to clubs and other groups for meetings and conventions. Each program is accompanied by a voice narration. There is no charge for using programs in the Foundation library, but users are expected to reimburse the NCDXF for nominal postage costs. Send an SASE to Josephine Clarke, WB6ZUC, 207 Evergreen Drive, Kentfield, CA 94904, USA to obtain a complete program listing.

The NCDXF Beacon Program

The Foundation maintains a network of nine beacon stations which operate sequentially on 14100 kHz. Each beacon transmits at the time, and in the sequence shown below, with an initial transmission at 100 watts. Power then is reduced in 10 dB steps to 10, 1 and 0.1 watts, followed by a sign-off and ID again at 100 watts. The sequence repeats every ten minutes, twenty four hours per day. The 10 dB power steps are precise and are useful for "S" meter calibration and for judging band conditions. The entire system was designed and built by Foundation volunteers at no cost except for the actual price of the hardware components.

Time	Station	Location
00:00	4U1UN/B	United Nations, NYC
00:01	W6WX/B	Stanford Univ., CA
00:02	KH6O/B	Honolulu Com. College
00:03	JA2IGY	Tokyo
00:04	4X4TU/B	Tel Aviv Univ.
00:05	OH2B	Espoo, Finland
00:06	CT3B	Madeira Island
00:07	ZS6DN/B	Transvaal, RSA
00:08	LU4AA	Argentina
00:09	(none)	(quiet)

NCDXF Logos

All members are encouraged to display the NCDXF logo on their QSL cards. NCDXF will supply members with camera-ready logo artwork without charge. For \$6.00 each, members may purchase Foundation logo lapel pins, logo rubber stamps, or a roll of 500 stick-on logos. Send your request for logo artwork or supplies order to the NCDXF Secretary. In Europe, these supplies may be obtained from Erik, SM0AGD.

The intent of this brief outline is to point out some of the many activities of the NCDXF and of a group of DXers who have given unselfishly of their time and effort over many years for the direct benefit of amateur radio in general and for the DX fraternity in particular.

Do Your Share. Join Up!



New Title Slides Highlight Foundation Shows

by Patty Winter, N6BIS

Recently Howard Brainen, WZ6Z, made up over 100 sets of welcoming and end slides for all the Foundation slide shows. Josephine Clarke, WB6ZUC, is now including the slides with the shows she mails out.

The first slide (which should appear before the title slide for the specific show) features a large NCDXF logo and our name, and says "Welcome! We hope you enjoy our presentation." The other slide has our name at the top, a slightly smaller version of the logo, and four phrases summarizing our activities. It also includes our mailing address.

The slides have a beautiful blue background with creamy yellow text. Their professional appearance is thanks to a pre-made design that I found included with the Microsoft PowerPoint program. On behalf of the Foundation, I'd also like to thank Presentation Technologies in Sunnyvale, California, for letting me use their desktop slidemaking machine. This way, I was able to send the designs right from a Macintosh to a 35mm camera! Amazing technology. (Along with a color scanner, this is how I made the most recent title slides for specific shows, too.)

Look for these eye-catching new slides next time you present a Foundation-sponsored show. Better yet, run out and order a show so you can see them right away!



The People Behind the Quotes

by Patty Winter, N6BIS

One of the most delightful aspects of putting together the new NCDXF display (see article in Summer 1989 newsletter) was reading the nice letters from people who agreed to let their comments about the Foundation be used on the display. More letters followed after they saw photos of the finished display. Here are some excerpts.

Reiner Petersen, one of our SWL members, tells about his DX adventures from his new home in Siegburg, Federal Republic of Germany: "This is a lovely ancient town, and we live just behind the hill with the monastery on its top. Siegburg is situated 10 kilometers northeast of Bonn on the eastern side of the Rhine River. The family also likes the new QTH though we are missing a little the fresh winds along the coast line. In any case the active antenna is on the roof, and DXing is quite OK down here too. The first new DXCC country was CY0DXX, and I do hope to get a CY0 QSL this time. I've got 280 countries confirmed."

Harry OK3EA writes that he works a lot of W's, "especially on ten meter SSB, a lot of W6's among them. I have a good signal (big antenna, you know, hi), so that I work a lot of mobiles, QRPs, etc." He also mentioned a few months ago that seven of his last 10 confirmed countries had been from operations assisted by the NCDXF. As Harry says, "This speaks for itself." It certainly does!

Arnfinn Kristoffersen, IA8CJ, not only let us use his quote about the Foundation's support for the 1987 Peter I expedition, but he also arranged to get copies of our new title slides for use at a recent presentation. He relates that "Erling LA6VM ran the Bouvetoya show at the Oslo branch of the Norwegian Radio Relay League. About 65 hams were present. It is many, because usually only 20-25 show up at meetings."



"After the Bouvetoya presentation, Erling showed some slides from the Peter I Island expedition. The last picture was the NCDXF end slide. While the picture was kept on the screen, he gave general information about the NCDXF organization and the support it gave to the LA-DX-Group Peter I Island DXpedition and other DXpeditions." Thanks, Arnfinn, for your help with Foundation publicity in Norway!

Don, N5CID, sent along an interesting history of his career as a Pan American Airlines flight radio officer, a merchant marine radio operator, and a broadcast disc jockey. Don notes that although he is now retired and must stay near home to care for his invalid wife, "I travel vicariously via ham radio in the comfort of my shack with no more jet lag or sea sickness! I owe many contacts with remote and exotic places to NCDXF supported DXpeditions."

"Incidentally, the Rotuma operation was of special interest to me because I was based at the Nadi airport in the Fiji Islands for several months during a Pan Am assignment." Don also sent along some photos of his shack, including his invaluable "second operator" Mila, a beautiful fluffy gray cat who seems to like sleeping near warm tube-based equipment such as amplifiers!

Some of the letters I've received about the display in the past few weeks have included expressions of concern about the earthquake here in the Bay Area on October 17th. I hope by now the word has gotten out that the Foundation gang is okay, although some lost mementos and had a lot of cleaning up to do.

By the way, we requested permission on more quotes than we had room for, because we weren't sure how many people we would hear from in time for our deadline. So, apologies to those whose quotes we weren't able to use this time; perhaps we can use them in future publicity efforts. My very great thanks to all of you for making the project so enjoyable.

37° 46' N 121° 12' W
CALIFORNIA
SAN JOAQUIN COUNTY
 MAIDENHEAD QTH-CM87JT

KA6BIM

CO ZONE 3		NORTHERN CALIFORNIA DX CLUB				ITU ZONE 6	
<input type="checkbox"/> QSO WITH	CONFIRMING GBO						
<input type="checkbox"/> SWL REPORT	DAY	MONTH	YEAR	UTC	MHZ	RBT	Z WAY
NCDXF							SSB-CW

DAVE TUCKER
 3877 E. WOODWARD AVE.
 MANTUCA, CA
 95336 U.S.A.

☐ PRR QBL ☐ TXX QBL 73 WAAW

Slide Shows and Videos

The Northern California DX Foundation has a number of slide shows and videos available for loan to organizations wishing to show them at meetings. Clubs borrowing materials are responsible for postage in both directions. The amount involved can be learned from the postage on the package when it comes to you and is usually about \$2.40. Please give the name of your club, the day of the month you meet and more than one choice of program in case there is a great demand for the item. Correspondence should be addressed to Josephine Clarke, WB6ZUC, 207 Evergreen Drive, Kentfield, CA 94904.

Available Slide Shows:

1. Kingman Reef and Palmyra Island expedition of 1974 (148 slides)
2. K5YY on Africa of 1978 (62 slides)
3. Colvins on Easter, Galapagos, San Andreas, etc. 1984 (140 slides)
4. W6RBC & ZL1AMO, Kermadec 1984 (58 slides)
5. AH0C (Saipan) CQWW Contest Operation of 1983 (82 slides)
6. 1985 Clipperton expedition (191 slides)
7. Ponape Island by N6HR, travelogue (81 slides)
8. Pribilof Island operation of 1982 (48 slides)
9. Midway by NA6T & KD7P (120 slides)
10. Antarctica, Arctowski, Palmer, Peter, Macquarie stations (101 slides)
11. VR6, Pitcairn, Mar/Apr 1979 by ZL1AMO & ZL1AD1 (51 slides)
12. SM0AGD 1982 Pacific DXpedition (150 slides)
13. 9U5, Burundi by ON5NT (57 slides)
14. TYA11, Benin by ON5NT (61 slides)
15. VK3DXU/2, Lord Howe Island by K2UO (52 slides)
16. 3A, Monaco, by F6EYS & F6HIX of 1984 (43 slides)
17. 5X5, Uganda by DJ6SI of 1985 (115 slides)
18. Market Reef, July 1983 by PA0GAM/OH0/OJ0
19. KX6DS, Marshall Island (34 slides)
20. Andorra, by DL1HBT, DL3HAH, DL5BAD, DL4BBO, DL4BAH (50 slides)
21. 1986 Clipperton DXpedition (176 slides)
22. Peter I Island, 3Y, of 1987 (127 slides)
23. KP2N, 1986, CQWW DX CW contest (55 slides)
24. OF0MA, Market Reef, 1987 (28 slides)
25. Abu Ail, A15AA, by DJ6SI, 1988 (65 slides)
26. XX9CW by DK7PE, 1986 (16 slides)
27. 1988 Palmyra by K9AJ, KP2A, WA2MOE, WORLX, F6EXV, JA5DQH (93 slides)
28. 1988 Kingman by the above operators (96 slides)
29. 1988 4U, KC4, VK9Y, VK9X and 9V1 by W7SW (73 slides)
30. Banaba Island T33JS+ T30 & T27 by KN6J & VK9NS (80 slides, 80 minutes)
31. XF4L by XE1L, XE1OH, XE1XA, OH2BH, OH2U, JH4RAF, W6RGG & N7NG

Available VHS videos:



1. XU1SS (plus BV0YL and BV0JA) (35 minutes)
2. 7J1RL of 1976 and 1978 (includes ZK9ZR, Mellish Reef)
3. VK9ZR DXpedition of 1978 (plus Ogassawara)
4. Frankford Radio Club ARRL phone parody + JH7YFL WWCW
5. JF1IST/7J1 DXpedition to Okino Torishima of 1979 (25 minutes)
6. Australian travelogue - Climbing Big Ben, Heard Island (55 minutes)
7. Ham Radio in the South Cook Islands by ZK1CA & ZK1CT (70 minutes)
8. VR6 by ZL1AMO & ZL1AD1 (copy of slide show above)
9. Looking Up in Rio Linda, 1986 by W6GO & K6HHD (45 minutes)
10. Revillagigedo, XF4DX, of 1987 (15 minutes)
11. Northern Texas Contest Club - towers and contesters (45 minutes)
12. It Started With A Broken Fence - JH3DPB Tall Tower tale (15 minutes)
13. Pile Up Busters, Humorous. (10 minutes)
14. FG/W2QM/FS, French St Martin, DXing Senior Style - Another Wrinkle to DXing
15. 1984 Laccadive Island DXpedition, VU7WCY, plus 1983 VK0HI from TV (60 minutes)
16. The K6UA contest station story (25 minutes)
17. HK0TU DXpedition of 1983, Malpelo (25 minutes in Spanish)
18. The Ship That Shouldn't Have - VK0JS Heard Island DXpedition (90 minutes)
19. The New World of Amateur Radio (28 minutes)
20. SDRASD 1987 by the Lynx Group, The Western Sahara Story (37 minutes)
21. Auckland Island 1988 by ZL1AMO, ZL1BQD, N7NG (60 minutes)
22. Dr. Owen Garriot's First Talk to hams about the Space Shuttle
23. Russian Ham Radio Tour by WA6WXD, Oct 1986 (45 minutes)
24. Peter I 3Y DXpedition 1987 - W4VWA copy of the slide show
25. Peter I, 1987, from JA7ARW
26. 1979 Spratly Isl DXpedition by K4SMX, K1MM, VK2BJL, N2OO, N4WW & KP2A
27. 1988 Mahj Vysokij Island by OH2BH, UZ3AU, OH5NZ, UR2AR, OH2RF, UW3AX (23 minutes)
28. 3W8DX & 3W8CW by HA5MY, HA5WA, HA5FP, HA5BBC, Nov 1988 Produced by W4BRE
29. Aruba, P40V CQWW Test 1988 (12 minutes)
30. A Message from Barry Goldwater, K7UGA (12 minutes)
31. Navassa of 1988 by N2EDF, K2SG, KE4VU, KD2NT, N4GNN, KT2Q, W3GH (38 minutes)
32. Rhodes, SV5, by N2OO and SV0AA, April 1989 (40 minutes)
33. NO1Z/KH1, Howland Isl 1988 by NO1Z, 7J3AAB, TR8JLD, VK9NS and VK9NL (20 minutes)
34. BEARS at the Great Wall of China, W7EA, K7LAY, KC7CF 1988 (audio + VHS 30 minutes)
35. Kansas City DX Club DXpedition to Tonganoxie Island (30 minutes)

CWP DX-PEDITION LNØ1 TT

ADJARIA USSR

RF5Q/UA3EAC

ZONE - 21, QBL-Ø14

CONFIRMING QSO WITH

DAY	MONTH	YEAR	UTC	MHZ	MODE	RST
SEP	89				2XCW SSB	VY75

TXN FR NICE QSO ES HPE CUAGH PSE TXN QSL VIA DIRECT

ANDY FOMENKO, P.O. BOX 16, 502028, CREL-28

VORONEZH USSR
ZONE 16 121



NCDXF03935 * IAR542272 HSC81440 * CWP
DIG03919 * AGCW41451 OF SECTOR KCC * NRS

TO RADIO	DAY	MONTH	YEAR	QMT	RST	MHZ	2WAY

PSE QSL TNX VIA P.O. BOX 88 MOSCOW

NF5Z/LJG
ST. LUCIA
 Paradise Isle of the Caribbean

CONFIRMING QSO WITH	DATE	TIME	MODE
DL VA RICHARD E. POWERS	1987	3.5 14 21 500	2X CW

J74Z
DOMINICA

CALIFORNIA
 SANTA CLARA COUNTY CONTRA COSTA COUNTY
 SANTA CRUZ COUNTY PLACER COUNTY

K6TMB WAZ

MEMBER: NORTHERN CALIFORNIA DX CLUB
 NORTHERN CALIFORNIA CONTEST CLUB

QSO WITH	DAY	MONTH	YEAR	UTC	MHz	RTT	2 WAY
NCDXF							SSB-CW

DL VA RICHARD E. POWERS 73

LOUIS J. BEAUDET
 1388 HORTON AVE.
 LOS ALTOS, CA 94024 U.S.A.

4U1UN/B
 W6WX/B
 KH6O/B
 JA2IGY
 LU4AA

**WORLDWIDE
 NORTHERN CALIFORNIA
 BEACON NETWORK**

4X6TU/B
 OH2B
 CT3B
 ZS6DN/B

The Foundation acknowledges with thanks and confirms your 14MHz beacon reception. The information is valuable and greatly appreciated.
 73!

DL9SC
 German Amateur Radio Station

CARL A. SCHALHORN
 SCHLEHENWEG 48
 D-7090 ALENWÜRTT.
 (Dist. from SW of BADENWÜRTT., 75 km S of STUTTGART)
 PED. REP. GERMANY

QTH: ALEN JASSBAU
 DOK P-22
 location: 10° 07' E
 49° 55' N
 ZONE 14, ITU 28
 A QSL IS THE FINAL COURTESY OF A QSO
 PSE QSL via DARC, D-3507 BAUNATAL-1, Postbox 1155 or direct

Northern California DX Foundation
 P.O. Box 2368
 Stanford, CA 94309-2368 USA

Address Correction Requested

NON-PROFIT ORGANIZATION
 U.S. POSTAGE PAID
 Permit #840
 Menlo Park, CA 94025



VE3SUN Apr. 89
 Peter Jennings
 P.O. Box 336
 Ben Lomond, CA 95005